



616 Moss Street  
Golden, Colorado  
80401

PHONE

303-277-1015

FAX

303-278-4880

**Architect:**

Opus Architects &  
Engineers, Inc.

**Contractor:**

Opus Northwest, L.L.C.

**Project Name**

Pulte Mortgage Bldg  
7390 S. Iola Ct.  
Englewood, CO

**Date:** 11-10-08

These drawings represent Aspen Drafting Inc's interpretation of information and the application of products provided by the architect. The sole purpose of these drawings is to assist the glazing subcontractor/fabricator in the fabrication and installation of the glazing. Ultimately the sole responsibility of verifying all the dimensions, quantities, design requirements, structural integrity and the architectural intent of the glazing is that of the glazing subcontractor/fabricator. However, it is equally important that the general contractor coordinate these drawings with all other affected subcontractors, the architect of record and the engineer. Aspen Drafting Inc. will not be held in any way liable for any errors and or omissions implied or otherwise.

These shop drawings must be approved by the architect and engineer prior to preparing the order placement and fabrication.

© 2007 Aspen Drafting Inc.  
The use of these documents and drawings shall be restricted to the original project for which they were prepared and any publication of these documents and drawings are expressly limited to such project.  
No reuse, reproduction or publication by any method, in whole or in part, of these documents and drawings is prohibited. Title of these documents and drawings remain with Aspen Inc.  
Aspen Drafting Inc. retains all federal, state and common law copyright protections.  
17 U.S.C. section 101 et seq.

**PRODUCED BY:**

**ASPEN DRAFTING**

6990 W. 38th. Ave.  
Suite #205  
Wheat Ridge, CO. 80033  
Phone: (303) 205-6394  
FAX: (303) 205-6392  
1-800-746-0641  
aspendrafting.com

no.	revisions by	date

drawn by : Duy Nguyen  
checked by : Dave McManis

**Engineer Stamp**

**SHEET 7.2 OF 25**

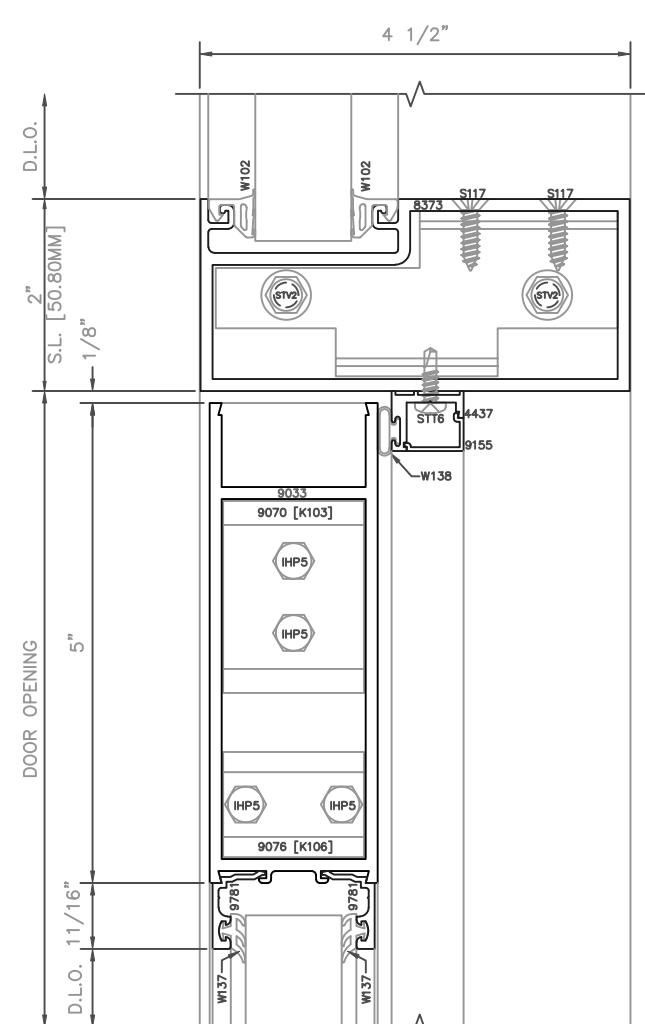

**1 DOOR HEAD DETAIL**  
SCALE: 6" = 1'-0"

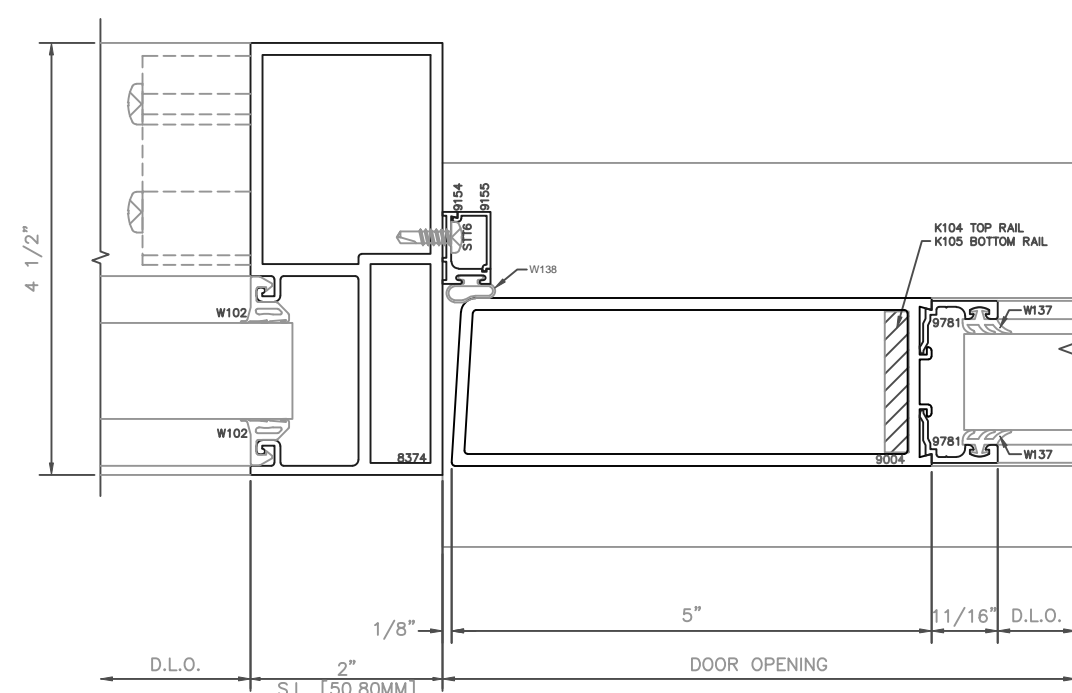

**3 DOOR JAMB DETAIL**  
SCALE: 6" = 1'-0"

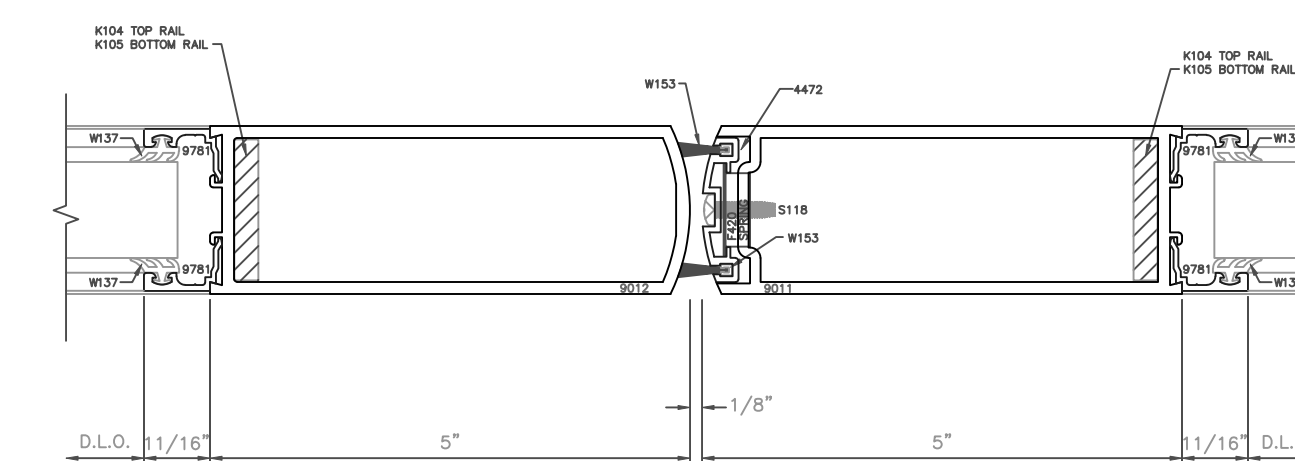

**4 DOOR MEETING STILE**  
SCALE: 6" = 1'-0"

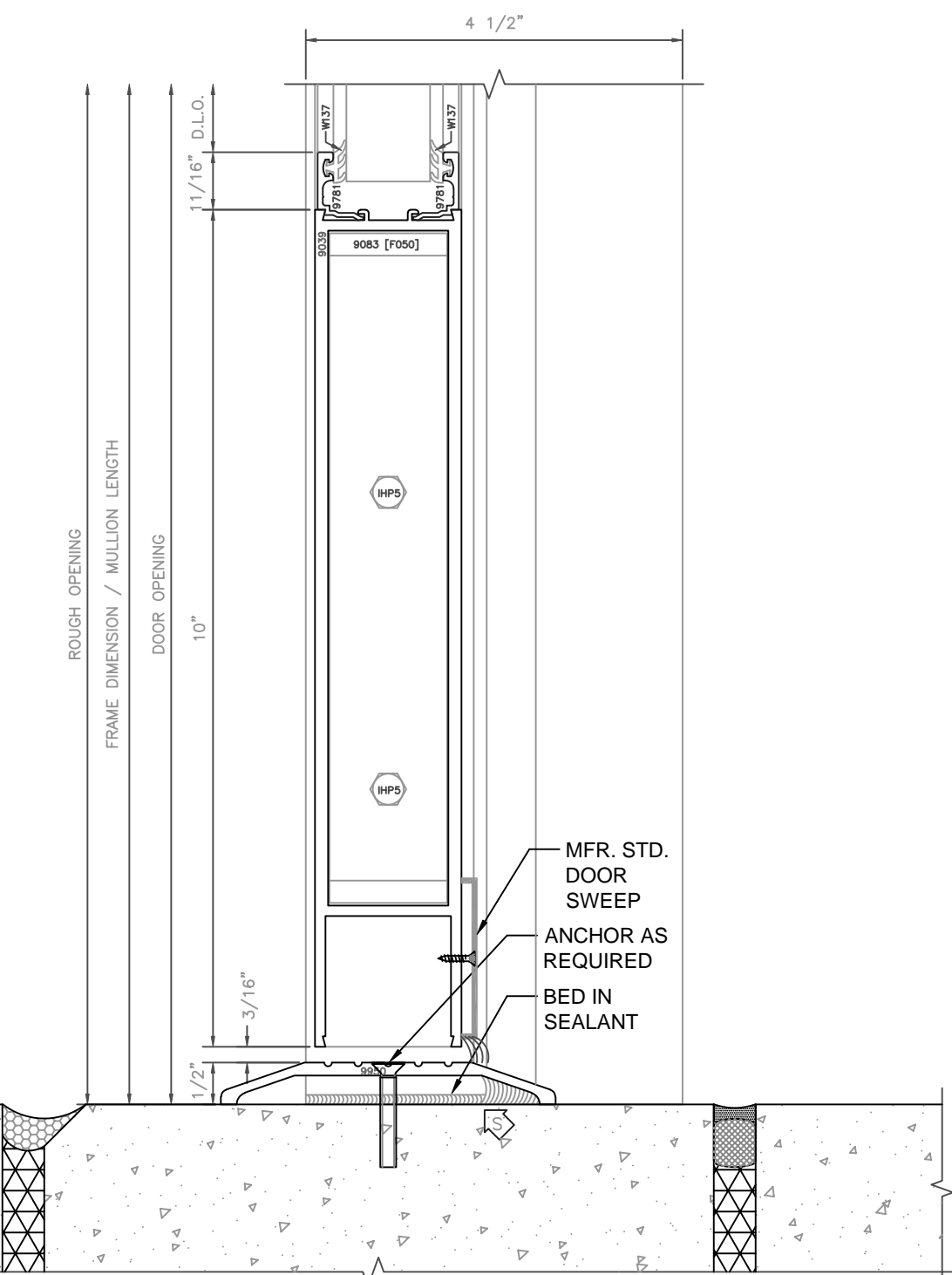

**2 THRESHOLD DETAIL**  
SCALE: 6" = 1'-0"

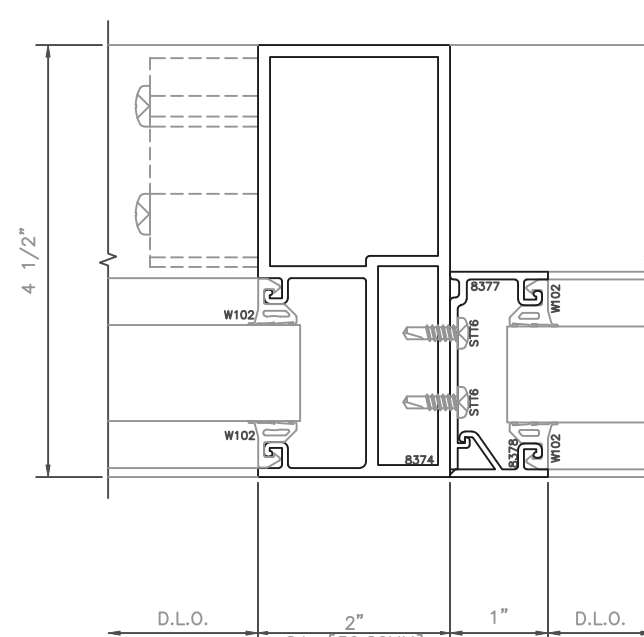

**5 TRANSOM DETAIL**  
SCALE: 6" = 1'-0"

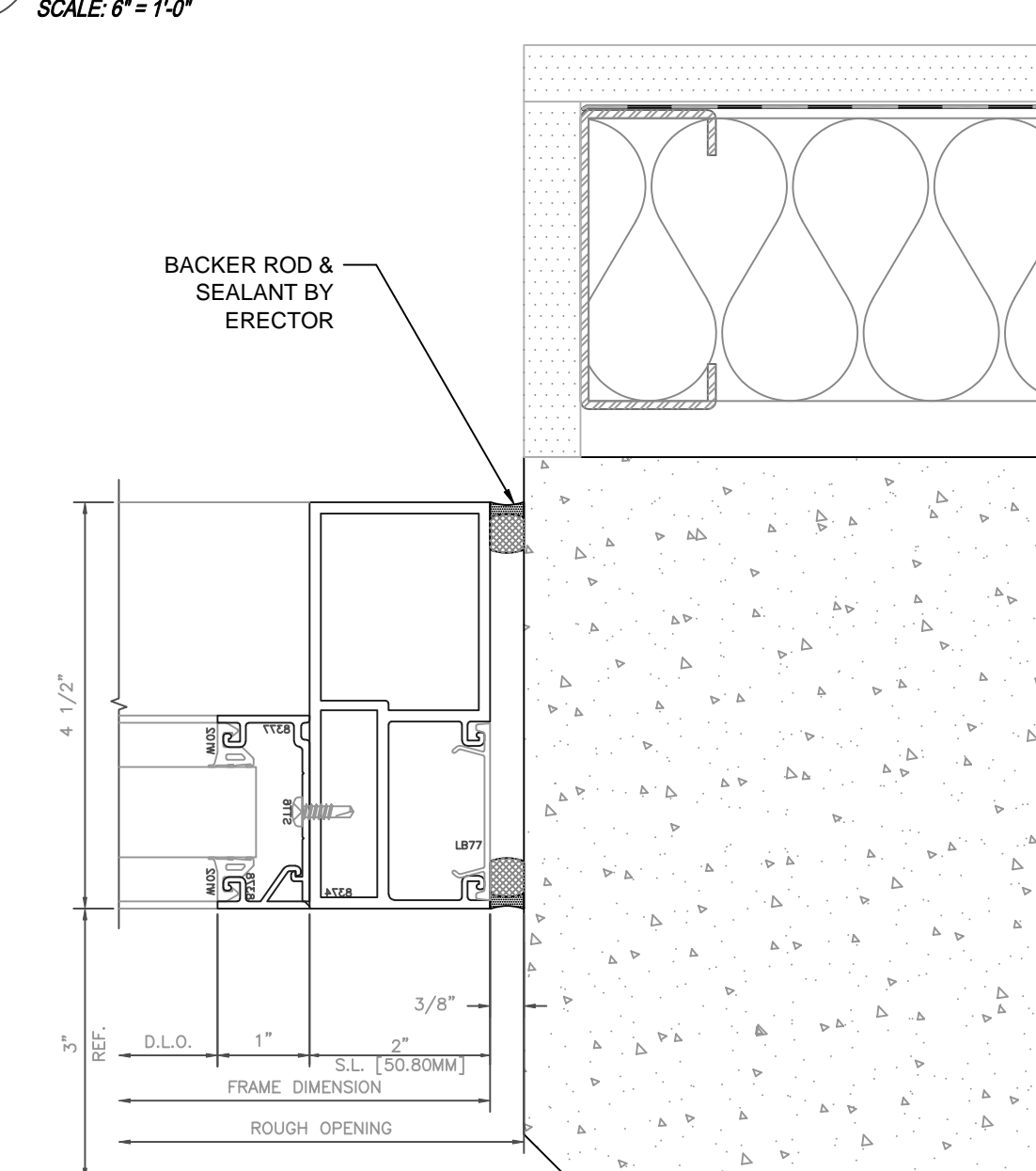

**6 TRANSOM @ JAMB DETAIL**  
SCALE: 6" = 1'-0"

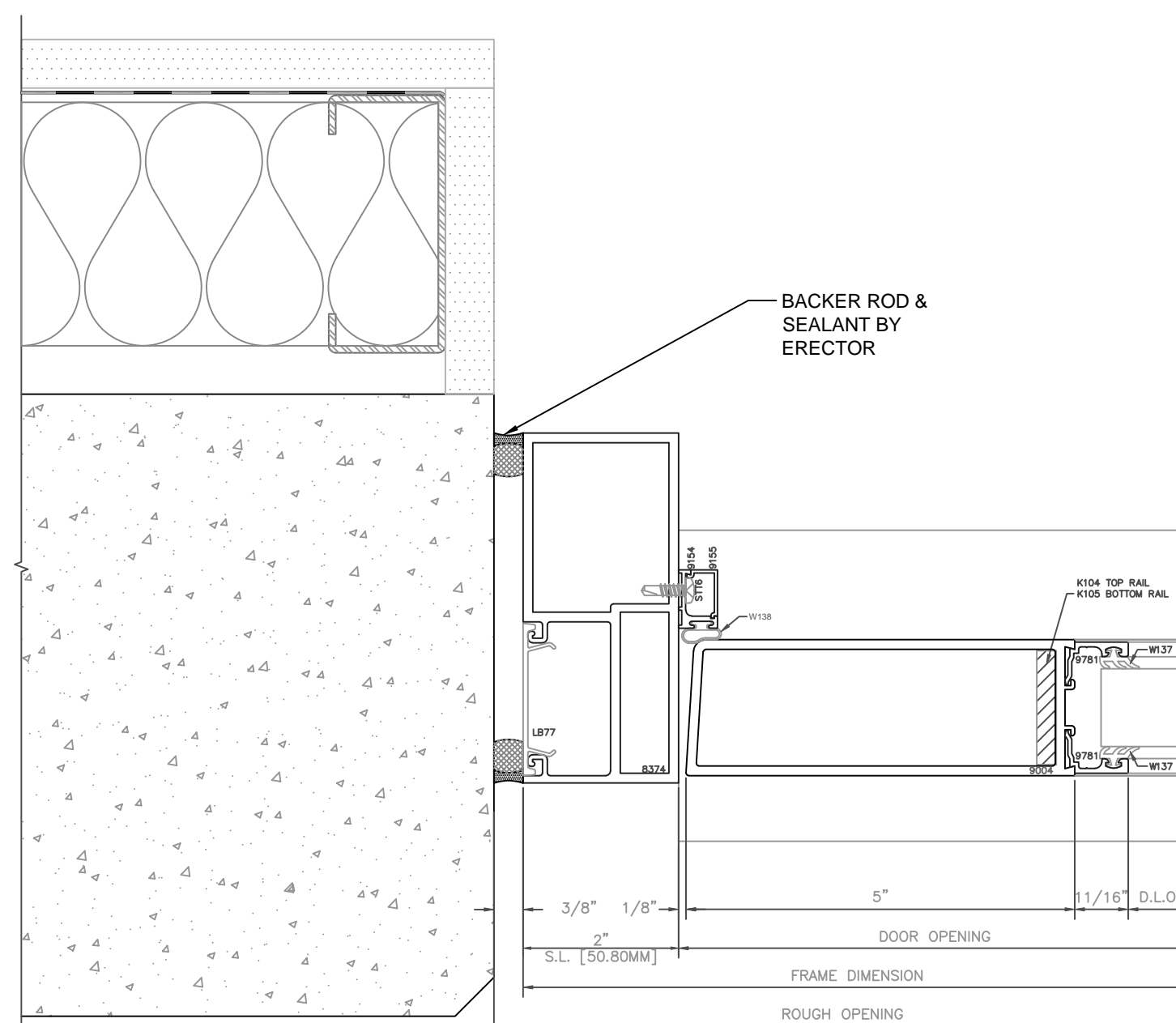

**7 DOOR JAMB DETAIL**  
SCALE: 6" = 1'-0"